

BURGA CLIP®



Burgaflex

Geachte cliënt,

Het doet ons genoegen U hiermede onze nieuwe catalogus van airconditioning slangen en fittingen te mogen presenteren, met de door Burgaflex ontworpen **BURGACLIP®** fitting technologie. Deze 'State of the Art' fitting is een doorbraak in de airconditioning industrie, waar tot op heden enkel opgeperste en verwisselbare koppelingen op de aircon slangen werden toegepast. Burgaflex maakt het U mogelijk middels een eenvoudige handeling de slang/fitting verbinding tot stand te brengen voor verschillende toepassingen in de aircon en/of transport koeling industrie.

De **BURGACLIP®** fitting technologie werd jaren getest op alle in onze industrie voorkomende speciale eisen (SAE J2064 en meer) en geeft U behalve het eerder genoemde assemblage voordeel ook een uitzonderlijk resultaat in lektheid, namelijk > 75% minder uitstoot dan de tot op dit moment in de markt beschikbare aircon slangen.

Niemand in onze industrie kent de airconditioning slangen en fittingen beter dan de medewerkers van Burgaflex en onze jarenlange ervaring geeft ons een absoluut voordeel boven andere leveranciers. Aarzel niet contact op te nemen met de Burgaflex vestigingen.

Wij danken U voor Uw vertrouwen.

Dear valued customer,

We have pleasure in presenting you our new catalogue of air conditioning hose and fittings with the developed **BURGACLIP®** fitting technology. This "State of the Art" Burgaflex hose fitting is a breakthrough in the air conditioning industry, where until this moment in time only crimp and/or field attachable fittings were used. Burgaflex allows you via a simple procedure, to attach the fitting to the hose for many applications in the Aircon/Transport and Commercial Refrigeration industry.

The **BURGACLIP®** fitting technology had been tested for years and all tests outlined and required by the industry, such as SAE J2064 and many more, have been taken into consideration. Apart from an easy and quick assembly of the fittings on the hose, we are proud to be able to advise you now, that this hose/fitting combination provides you a permeation rate, which is > 75% less than the presently available air conditioning hose assemblies on the market.

No one knows the air conditioning hoses and fittings better than the people at Burgaflex. Our many years of experience give us a big advantage over other suppliers. By specializing in just one type of product, we have more to offer in terms of range and sizes, customer service and technical assistance. We will be only pleased to send you a quotation for products, which may be of a specific design but are not shown in our brochure. Please do not hesitate to contact the Burgaflex plants.

Thank you for doing business with Burgaflex.

Cher client,

Nous avons le plaisir de vous présenter notre nouveau catalogue de tuyaux et raccords pour l'air conditionné, actualisé de notre technologie de raccordement **BURGACLIP®**. Ce nouveau type de raccord est une révolution dans l'industrie de l'air conditionné, pour laquelle n'étaient disponibles jusqu'à présent que les raccords sertis ou vissés. Burgaflex vous permet, désormais, l'emploi d'une méthode simple de raccordement des tuyaux pour nombre d'applications dans les domaines de la climatisation et de la réfrigération automobile.

La technologie **BURGACLIP®** a été de trois ans selon les normes requises par cette industrie, telle la SAE J2064 et autres également prises en considération. En dehors d'un emploi simple et rapide du mode de raccordement sur le tuyau, nous sommes fiers de vous annoncer, de plus, que cette combinaison tuyau/raccord résulte en une diffusion de > 75% inférieure aux canalisations actuellement disponibles sur le marché.

Personne ne connaît mieux les tuyaux et raccords d'air conditionné que Burgaflex. Notre longue expérience nous procure un avantage précieux par rapport aux autres fournisseurs. Spécialistes de cette fonction, nous avons plus à offrir en terme de gamme, dimensions, service clientèle et assistance technique. Nous serons heureux de répondre à vos demandes, y compris pour des conceptions spécifiques non illustrées dans notre brochure. N'hésitez pas à contacter les unités Burgaflex.

Merci de votre confiance.

Sehr geehrter Kunde,

wir freuen uns, Ihnen unseren Katalog für Kältemittelschläuche und Fittings mit der neu entwickelten **BURGACLIP®** Technologie präsentieren zu dürfen. Dieses, dem Stand der Technik entsprechenden Burgaflex-Schlauch-Fitting stellt einen Durchbruch für den Bereich der Klimaanlage-Industrie dar, wo bisher nur Press- und Schraubarmaturen verwendet wurden. Burgaflex ermöglicht es Ihnen mit einem äußerst einfachen Prozess, Fitting/Schlauchverbindungen für vielfältige Anwendungen in der Klima- und Transportkältetechnik herzustellen.

Das **BURGACLIP®** System wurde langjährig getestet, wobei alle Prüfungen, die von der Kälteanlagenindustrie gefordert werden - insbesondere die SAE J2064 - berücksichtigt wurden.

Mit Stolz können wir Ihnen, neben der einfachen und schnellen Montage, einen Kältemittelschlauch zur Verfügung stellen, der bis > 75% niedrigere Permeationswerte als andere auf dem Markt verfügbare Produkte aufweist.

Wir von Burgaflex sind Ihre Fachleute für Kältemittelleitungen, -Schläuche und Fittings. Unsere langjährige Erfahrung ist Ihr Vorteil.

Durch Spezialisierung auf eine Produktparte können wir Ihnen eine äußerst große Teilevielfalt, einen überlegenen Kundenservice sowie kompetente technische Unterstützung anbieten.

Wir freuen uns, Ihnen Teile aus unserem Standardprogramm als auch kundenspezifisch abgestimmte Teile, die Sie nicht in unserem Katalog finden, anbieten zu dürfen.

Bitte zögern Sie nicht, unsere Werke zu kontaktieren.

Wir danken Ihnen für Ihr Vertrauen.

Değerli Müşterilerimiz,

Klima hortum bağlantılarında yeni geliştirilen **BURGACLIP®** rakorlama sistem kataloğunu size sunmaktan memnuniyet duyuyoruz. Bugüne kadar kullanılan geleneksel rakorların ötesinde; yeni Burgaflex hortum rakorlama sistemleri soğutma endüstrisinde bir dönüm noktası oluşturmaktadır.

Burgaflex, soğutma sektörü ve ticari araçlar klima ve soğutucu uygulamalarında hortum ve rakor bağlantılarına basit bir metotla çözüm getirmektedir.

BURGACLIP® teknolojisini SAE J2064 ve diğer uluslararası standartların öngördüğü şekilde ve üç yıldan daha fazla bir süre ile test edilmiştir. Hortum ve rakorlarda hızlı ve kolay bağlantı sağlamanın yanı sıra bu sistem piyasada mevcut klima hortum bağlantılarına göre yılda %75 daha az gaz geçirgenliğine sahiptir.

Hiç kimsenin klima hortum ve rakorlarını Burgaflex'den daha iyi tanıyamayacağını düşünüyoruz. Burgaflex, sektöründe uzun yıllar boyunca belirli bir ürün tipi üzerinde haklı deneyim kazanmış olmanın avantajıyla, ürün temin etmenin ötesinde müşteri odaklı hizmet ve teknik destek sunmaktadır. Bu katalogta bulunmayan özel uygulamalara yönelik tasarlanmış ürünler için bile Burgaflex sizlerin taleplerine yanıt vermekten memnuniyet duyacaktır. Burgaflex ve Türkiye'deki merkezlerinden biri ile iletişime geçmeniz yeterli olacaktır.

Burgaflex ile çalıştığınız için teşekkür ederiz.

FITTINGEN
FITTINGS
RACCORDS
ARMATUREN
RAKORLAR



Pag. 14 - Stainless steel clip



Pag. 14 - Plastic Clipholder

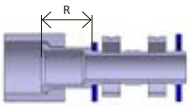

Pag. 5 - SAE 45° flare swivel

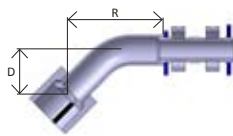

Pag. 5 - 45° elbow

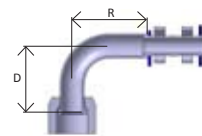

Pag. 5 - 90° elbow

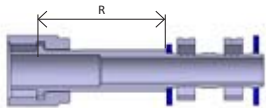

Pag. 6 - "O" ring female swivel - tube connection

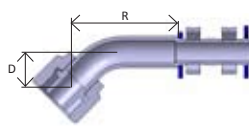

Pag. 7 - 45° elbow

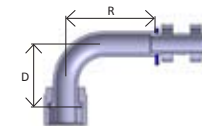

Pag. 9 - 90° elbow

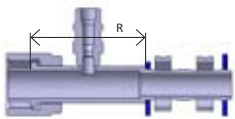

Pag. 6 - "O" ring female swivel - R134 valve

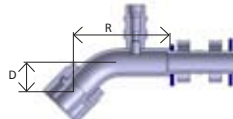

Pag. 8 - 45° elbow

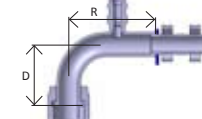

Pag. 9 - 90° elbow

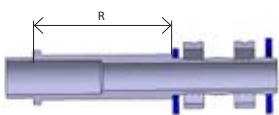

Pag. 6 - "O" ring, without nut

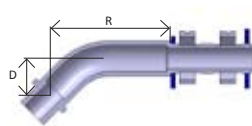

Pag. 8 - 45° elbow

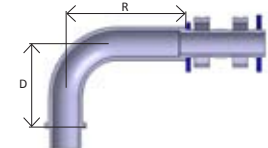

Pag. 13 - 90° elbow

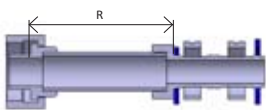

Pag. 7 - Tube "O" compressor fitting

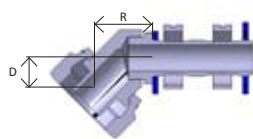

Pag. 8 - 45° elbow

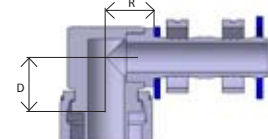

Pag. 12 - 90° elbow

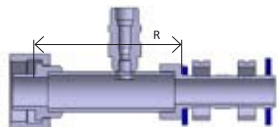

Pag. 7 - Tube "O" compressor fitting/R134 valve

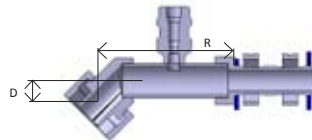

Pag. 9 - 45° elbow

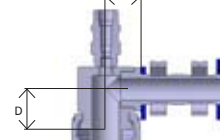

Pag. 12 - 90° elbow

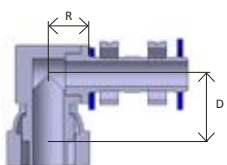

Pag. 10/11 - "O" ring female swivel, 90° blocktype

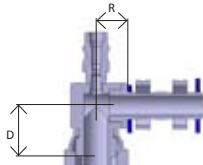

Pag. 10 - with R134A valve

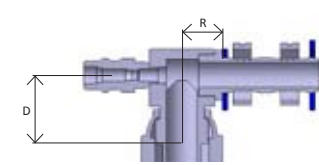

Pag. 10/11 - with R134A valve

Fittingen uit één stuk of bestaande uit delen hebben een overeenkomstige maatvoering. Beide uitvoeringen kunnen worden geleverd.
One piece fittings or composed of parts have the same measurements. Both versions can be supplied.
Raccords d'une seule pièce ou composé de pièces ont les mêmes dimensions. Les deux versions peuvent être fournies.
Armaturen aus einem Stück oder aus mehreren Stücken haben dieselbe Abmessungen. Beide Ausführungen können geliefert werden.
Tek parçadan oluşan rakorlar veya parça bileşenleri aynı ölçülere sahiptir. Her iki tipin de temini mümkündür.

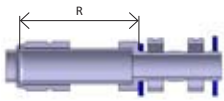

Pag. 13 - "O" ring male swivel

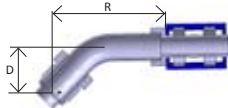

Pag. 13 - 45° elbow

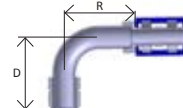

Pag. 14 - 90° elbow

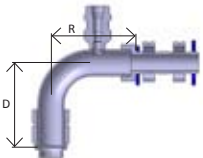

Pag. 14 - "O" ring male swivel - 90° with R134 valve

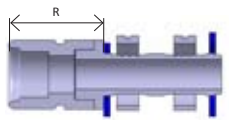

Pag. 15 - Male insert "O" ring, straight

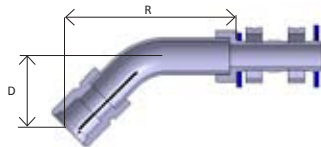

Pag. 15 - 45° elbow

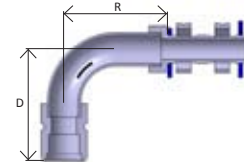

Pag. 15 - 90° elbow

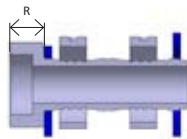

Pag. 16 - Braze nipple

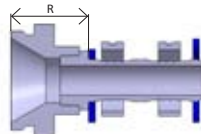

Pag. 16 - Quick disconnect connection

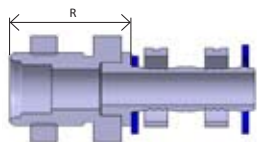

Pag. 16 - Bulkhead male insert "O" ring

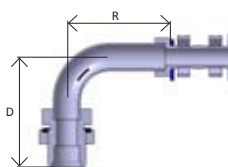

Pag. 17 - 45° elbow

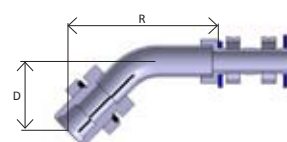

Pag. 17 - 90° elbow

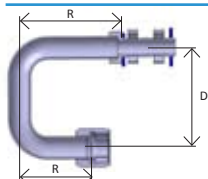

Pag. 17 - "O" ring female swivel - 180°

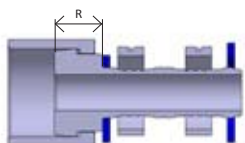

Pag. 18 - ORFS female swivel

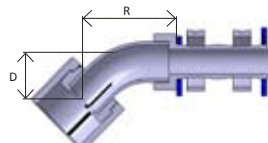

Pag. 18 - 45° elbow

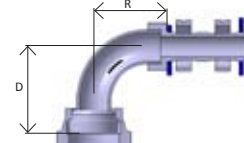

Pag. 18 - 90° elbow

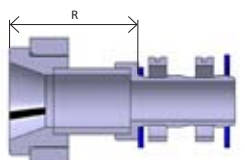

Pag. 19 - "Bock" flange connection

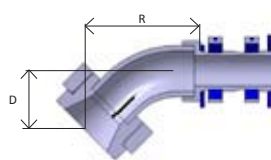

Pag. 19 - "Bock" flange 45° elbow

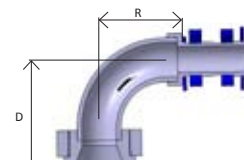

Pag. 19 - "Bock" flange 90° elbow

FITTINGEN
FITTINGS
RACCORDS
ARMATUREN
RAKORLAR

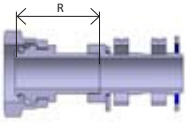

Pag. 20 - Metric swivel light series

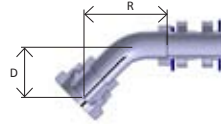

Pag. 20 - 45°

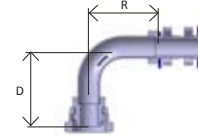

Pag. 20 - 90° elbow

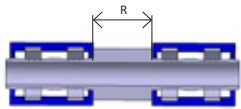

Pag. 22 - In line splicer

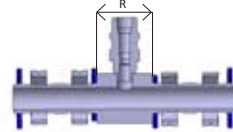

Pag. 21 - In line splicer - R134 valve

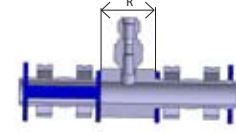

Pag. 22 - In line splicer - R12 valve

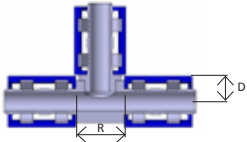

Pag. 21 - T-splicer

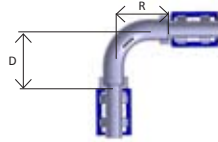

Pag. 21 - 90° elbow splicer

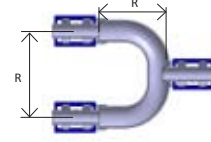

Pag. 22 - Y-splicer

SLANG HOSE TUYAU SCHLAUCH HORTUM	bestel nr.	slangmaat	binnen diam.	buiten diam.	min. barst druk	werkdruk	min. buigstraal
	part no.	hose size	hose I.D.	hose O.D.	min. burst press	work press	min. bend rad
	référéncé	module	diamètre intérieur	diamètre extérieur	pres. minimum d'éclatement	pres d'utilisation	rayon mini de courbure
	Artikel Nr.	Schlauchgröße	Innen Durchm.	Außen Durchm	Min Berstdruck	Betriebsdruck	Biegeradius
	parça no	hortum ölçüsü	hortum iç çapı	hortum dış çapı	min. patlama basıncı	çalışma basıncı	min. bükme yarıçapı

Slangconstructie : Een naadloze binnenslang van synthetische (CR) rubber, ommanteld met een nylon tube en versterkt met 1 braid. Buitenmantel van een slijtvaste oliebestendige synthetische rubber (Butyl), welke geperforeerd is.

Kenmerk : Slang wordt aangeduid door bestelnummer en slangmaat.

Toepassing : Speciaal ontworpen voor het gebruik met Freon 12 - R134A - Suva MP52, R22, HFO1234yf.

Temperaturen : -35°C tot +125°C

Hose construction: Seamless synthetic rubber (CR) innertube, covered with a nylon layer and reinforced with one braid. Hose has a weather, oil and abrasion resistant rubber cover (Butyl), which is perforated.

Identification Uses : Hose is identified by partnumber and size. Designed specifically for automotive and commercial lines carrying Freon 12 - R134A - Suva MP52, R22 and HFO1234yf.

Temperatures : -35°C thru +125°C

Schlauchaufbau : Synthetischer (CR) nahtloser Gummi Innenschlauch, mit einer Nylonzwischenlage, PET Druckträger. Wetter- und abriebbeständige Decke aus Chlorbutyl (CIIR) mit geringer Wasser dampfdurchlässigkeit, Decke nadel gestochen.

Kennzeichnung : Der Schlauch ist mit abriebfestem Aufdruck von Artikelnummer und Größe gekennzeichnet.

Anwendungen : Entwickelt für Automobiel- und Industrielle Anwendungen mit R134a, HFO1234yf sowie für die meisten Blends und Kältemaschinenöle.

Temp.bereich : -35°C bis +125°C

		min. inch/mm	max inch/mm	min. inch/mm	max inch/mm	PSI/bar	PSI/bar	inch/mm
3090-06	- 6 5/16"	0.300 7.9	0.330 8.6	0.560 14.2	0.600 15.2	2500 >172	500 35	2.00 51
3090-08	- 8 13/32"	0.400 10.2	0.440 11.2	0.660 16.8	0.700 17.8	2500 >172	500 35	2.50 64
3090-10	- 10 1/2"	0.490 12.5	0.530 13.5	0.745 18.9	0.785 19.9	1750 >121	500 35	3.00 76
3090-12	- 12 5/8"	0.615 15.6	0.655 16.6	0.910 23.1	0.950 24.1	1750 >121	500 35	4.00 102
3090-14	- 14 3/4"	0.745 18.9	0.785 19.9	1.105 28.1	1.145 29.1	1750 >121	500 35	9.85 250
3090-16*	- 16 7/8"	0.866 22	0.866 22	1.22 31	1.22 31	1750 >121	500 35	-
* indication specifications								

Construction : Tube intérieure caoutchouc synthétique (CR), une couche en nylon, renforcé par 1 braid avec une robe extérieure de caoutchouc synthétique (Butyl).

Identification : Le tuyau est identifié pas sa référence et son module.

Utilisation : Circuits de réfrigération Freon 12 - R134A - Suva MP52, R22, HFO1234yf

Températures : -35°C à +125°C

Hortum yapısı : Hortum iç katmanı sentetik kauçuk (CR), naylon tabaka giydirilmiş ve tek sıra örme. Hortum iklim şartlarına, soğutucu yağ ve aşındırıcılara karşı dirençli (Butyl) kauçuk ile kaplanmış ve perfore edilmiştir.

Tanımlama : Hortum çap ölçüsüne göre tanımlanır.

Kullanım Alanı : Otomotiv ve ticari araç soğutucularında kullanılan yaygın Freon 12 - R134a - Suva MP52, R22 ve HFO1234yf soğutucu gazlarına uygun olarak tasarlanmış ve geliştirilmiştir.

Çalışma sıcaklığı : - 35 °C ile +125 °C

Fittingen uit één stuk of bestaande uit delen hebben een overeenkomstige maatvoering. Beide uitvoeringen kunnen worden geleverd. One piece fittings or composed of parts have the same measurements. Both versions can be supplied. Raccords d'une seule pièce ou composé de pièces ont les mêmes dimensions. Les deux versions peuvent être fournies. Armaturen aus einem Stück oder aus mehreren Stücken haben dieselbe Abmessungen. Beide Ausführungen können geliefert werden. Tek parçadan oluşan rakorlar veya parça bileşenleri aynı ölçülere sahiptir. Her iki tipin de temini mümkündür.

FREON SLANGFITTINGEN
 FREON HOSE FITTINGS
 RACCORDS POUR TUYAUX AIRCONDITIONNE
 ARMATUREN FÜR KÄLTEMITTELSCHLAUCH
 FREON HORTUM RAKORLARI



Ref. BURGA CLIP®	aansluitmaat fitt.conn.size module du filetage Größe Verschraubung rakor ölçüsü	slangmaat hoze size module du tuyau Schlauchgröße hortum ölçüsü	draad thread filetage Gewinde diş ölçüsü	ventiel valve valve Ventil subap	D	R	FITTINGEN FITTINGS RACCORDS ARMATUREN RAKORLAR
----------------------------	---	---	--	--	---	---	--

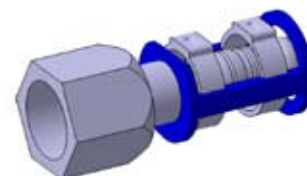
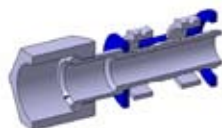

54701-04-06S	- 4	- 6	7/16-20			15
54701-06-06S	- 6	- 6	5/8-18			15
54701-08-06S	- 8	- 6	3/4-16			17
54701-06-08S	- 6	- 8	5/8-18			15
54701-08-08S	- 8	- 8	3/4-16			17
54701-08-10S	- 8	-10	3/4-16			17
54701-10-08S	-10	- 8	7/8-14			20
54701-10-10S	-10	-10	7/8-14			20
54701-12-12S	-12	-12	1 1/16-14			22
54701-12-14S	-12	-14	1 1/16-14			22
54701-16-16S	-16	-16	1 5/16-14			35

SAE 45° wartel
 SAE 45° flare swivel
 Femelle tournant SAE 45°
 Fitting, gerade mit SAE-Dichtkopf 45°

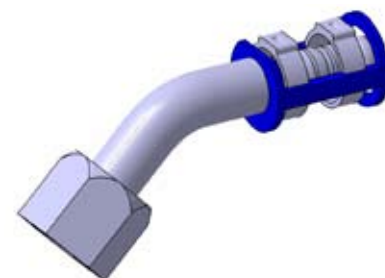

54702-04-06S	- 4	- 6	7/16-20		20	47
54702-06-06S	- 6	- 6	5/8-18		15	40
54702-08-08S	- 8	- 8	3/4-16		15	47
54702-10-10S	-10	-10	7/8-14		25	52
54702-12-12S	-12	-12	1 1/16-14		27	62
54702-12-14S	-12	-14	1 1/16-14		27	62
54702-16-16S	-16	-16	1 5/16-14		35	80

SAE 45° wartel - 45° elleboog
 SAE 45° flare swivel - 45° elbow
 Femelle tournant SAE 45° - coudé 45°
 Fitting, 45° mit SAE-Dichtkopf 45°



54703-04-06S	- 4	- 6	7/16-20		40	40
54703-06-06S	- 6	- 6	5/8-18		40	32
54703-06-08S	- 6	- 8	5/8-18		30	32
54703-08-06S	- 8	- 6	3/4-16		32	40
54703-08-08S	- 8	- 8	3/4-16		32	40
54703-08-10S	- 8	-10	3/4-16		32	40
54703-10-08S	-10	- 8	7/8-14		45	50
54703-10-10S	-10	-10	7/8-14		45	50
54703-10-12S	-10	-12	7/8-14		45	50
54703-12-12S	-12	-12	1 1/16-14		50	75
54703-16-16S	-16	-16	1 5/16-14		60	80

SAE 45° wartel - 90° elleboog
 SAE 45° flare swivel - 90° elbow
 Femelle tournant SAE 45° - coudé 90°
 Fitting, 90° mit SAE-Dichtkopf 45°



FREON SLANGFITTINGEN
FREON HOSE FITTINGS
RACCORDS POUR TUYAUX AIRCONDITIONNE
ARMATUREN FÜR KÄLTEMITTELSCHLAUCH
FREON HORTUM RAKORLARI

FITTINGEN FITTINGS RACCORDS ARMATUREN RAKORLAR	Ref. BURGA CLIP®	aansluitmaat fitt.conn.size module du filetage Größe Verschraubung rakor ölçüsü	slangmaat hoze size module du tuyau Schlauchgröße hortum ölçüsü	draad thread filetage Gewinde diş ölçüsü	ventiel valve valve Ventil subap	D	R
--	----------------------------	---	---	--	--	---	---

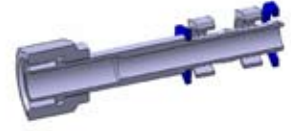
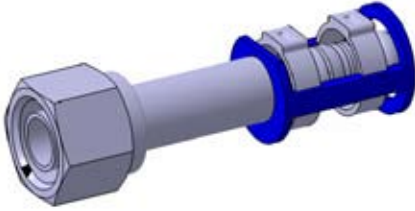

54704-06-06S	- 6	- 6	5/8-18			37
54704-06-08S	- 6	- 8	5/8-18			37
54704-08-06S	- 8	- 6	3/4-16			42
54704-08-08S	- 8	- 8	3/4-16			42
54704-10-08S	-10	- 8	7/8-14			50
54704-08-10S	- 8	-10	3/4-16			42
54704-10-10S	-10	-10	7/8-14			50
54704-12-10S	-12	-10	1 1/16-14			55
54704-10-12S	-10	-12	7/8-14			50
54704-12-12S	-12	-12	1 1/16-14			55
54704-12-16S	-12	-16	1 1/16-14			55

"O" ring wartel - pijp aansluiting
 "O" ring female swivel - tube connection
 "O" ring femelle tournant - tube connection
 Fitting, gerade mit ORL und Ü-Mutter



54717-06-06S	- 6	- 6	5/8-18	16		37
54717-08-08S	- 8	- 8	3/4-16	16		42
54717-08-10S	- 8	-10	3/4-16	13		42
54717-10-10S	-10	-10	7/8-14	13		50
54717-10-12S	-10	-12	7/8-14	13		50
54717-12-12S	-12	-12	1 1/16-14	13		55
54717-12-14S	-12	-14	1 1/16-14	13		55
54717-12-16S	-12	-16	1 1/16-14	13		55

"O" ring wartel, R134 ventiel
 "O" ring female swivel, R134 valve
 "O" ring femelle tournant, R134 valve
 Fitting, gerade mit ORL und Ü-Mutter, mit FV R134a

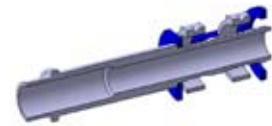
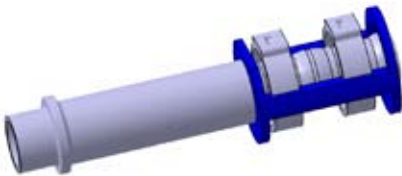

54724-06-06S	- 6	- 6				37
54724-08-08S	- 8	- 8				42
54724-10-10S	-10	-10				50
54724-10-12S	-10	-12				50
54724-12-12S	-12	-12				55
54724-12-10S	-12	-10				55
54724-12-14S	-12	-14				55
54724-12-16S	-12	-16				55

"O" ring - pijp zonder moer
 "O" ring tube connection, without nut
 "O" ring tube connection, sans écrou
 Fitting, gerade, ORL ohne Ü-Mutter

Fittingen uit één stuk of bestaande uit delen hebben een overeenkomstige maatvoering. Beide uitvoeringen kunnen worden geleverd.
 Raccords d'une seule pièce ou composé de pièces ont les mêmes dimensions. Les deux versions peuvent être fournies.
 Armaturen aus einem Stück oder aus mehreren Stücken haben dieselbe Abmessungen. Beide Ausführungen können geliefert werden.
 Tek parçadan oluşan rakorlar veya parça bileşenleri aynı ölçülere sahiptir. Her iki tipin de temini mümkündür.

FREON SLANGFITTINGEN
FREON HOSE FITTINGS
RACCORDS POUR TUYAUX AIRCONDITIONNE
ARMATUREN FÜR KÄLTEMITTELSCHLAUCH
FREON HORTUM RAKORLARI



Ref. BURGACLIP®	aansluitmaat fitt.conn.size module du filetage Größe Verschraubung rakor ölçüsü	slangmaat hoze size module du tuyau Schlauchgröße hortum ölçüsü	draad thread filetage Gewinde diş ölçüsü	ventiel valve valve Ventil subap	D	R	FITTINGEN FITTINGS RACCORDS ARMATUREN RAKORLAR
---------------------------	---	---	--	--	---	---	--

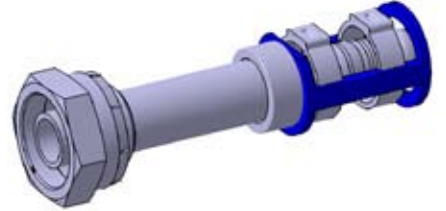

54707-10-08S	-10	- 8	1-14			57
54707-10-10S	-10	-10	1-14			57
54707-10-12S	-10	-12	1-14			57

Tube "O" compressor wartel
Tube "O" compressor fitting
Raccord tube "O" compresseur
Kompressoranschluss, gerade, "Tube O"

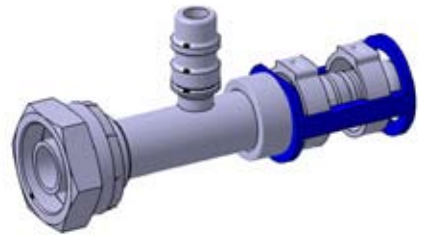

54733-10-08S	-10	- 8	1-14	16		57
54733-10-10S	-10	-10	1-14	13		57
54733-10-12S	-10	-12	1-14	13		57

Tube "O" compressor wartel/R134 ventiel
Tube "O" compressor fitting/R134 valve
Raccord tube "O" compresseur/R134 valve
Kompressoranschluss, gerade, "Tube O"/FV R134a



54705-06-06S	- 6	- 6	5/8-18		15	37
54705-08-06S	- 8	- 6	3/4-16		15	52
54705-08-08S	- 8	- 8	3/4-16		15	52
54705-08-10S	- 8	-10	3/4-16		15	52
54705-10-10S	-10	-10	7/8-14		17	55
54705-12-10S	-12	-10	1 1/16-14		25	65
54705-10-12S	-10	-12	7/8-14		17	55
54705-12-12S	-12	-12	1 1/16-14		25	65
54705-12-14S	-12	-14	1 1/16-14		25	65
54705-12-16S	-12	-16	1 1/16-14		25	65

"O" ring wartel 45° - pijp aansluiting
"O" ring female 45° swivel - tube connection
"O" ring femelle tournant 45° - tube connection
Fitting, 45° mit ORL und Ü-Mutter



FREON SLANGFITTINGEN
FREON HOSE FITTINGS
RACCORDS POUR TUYAUX AIRCONDITIONNE
ARMATUREN FÜR KÄLTEMITTELSCHLAUCH
FREON HORTUM RAKORLARI

FITTINGEN FITTINGS RACCORDS ARMATUREN RAKORLAR	Ref. BURGA CLIP®	aansluitmaat fitt.conn.size module du filetage Größe Verschraubung rakor ölçüsü	slangmaat hoze size module du tuyau Schlauchgröße hortum ölçüsü	draad thread filetage Gewinde diş ölçüsü	ventiel valve valve Ventil subap	D	R
--	----------------------------	---	---	--	--	---	---

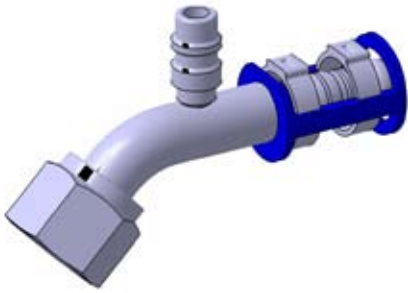

54718-06-06S	- 6	- 6	5/8-18	16	15	37
54718-08-08S	- 8	- 8	3/4-16	16	15	52
54718-10-10S	-10	-10	7/8-14	13	17	55
54718-10-12S	-10	-12	7/8-14	13	25	65
54718-12-12S	-12	-12	1 1/16-14	13	25	65
54718-12-14S	-12	-14	1 1/16-14	13	25	65
54718-12-16S	-12	-16	1 1/16-14	13	25	65

"O" ring wartel, 45°/R134 ventiel
 "O" ring female swivel, 45°/R134 valve
 "O" ring écrou tournant, 45°/R134 valve
 Fitting, 45° mit ORL und Ü-Mutter mit FV R134a



54725-06-06S	- 6	- 6			15	37
54725-08-08S	- 8	- 8			15	52
54725-10-10S	-10	-10			17	55
54725-12-10S	-12	-10			25	65
54725-12-12S	-12	-12			25	65
54725-12-14S	-12	-14			25	65
54725-12-16S	-12	-16			25	65

"O" ring - pijp zonder moer, 45° gebogen
 "O" ring tube connection without nut, 45°
 "O" ring tube connection sans écrou, 45°
 Fitting, 45°, ORL ohne Ü-Mutter

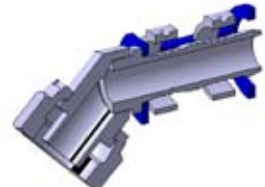
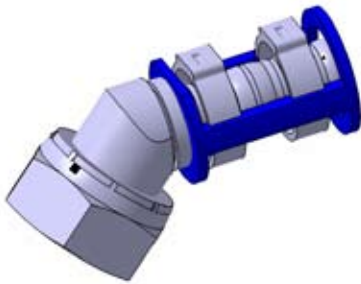

54708-10-08S	-10	- 8	1-14		10	18
54708-10-10S	-10	-10	1-14		10	18
54708-10-12S	-10	-12	1-14		10	18

Tube "O" compressor wartel, 45° gebogen
 Tube "O" compressor fitting, 45° elbow
 Raccord tube "O" compresseur, coudé 45°
 Kompressoranschluss, 45°, "Tube O"

Fittingen uit één stuk of bestaande uit delen hebben een overeenkomstige maatvoering. Beide uitvoeringen kunnen worden geleverd.
 One piece fittings or composed of parts have the same measurements. Both versions can be supplied.
 Raccords d'une seule pièce ou composé de pièces ont les mêmes dimensions. Les deux versions peuvent être fournies.
 Armaturen aus einem Stück oder aus mehreren Stücken haben dieselbe Abmessungen. Beide Ausführungen können geliefert werden.
 Tek parçadan oluşan rakorlar veya parça bileşenleri aynı ölçülere sahiptir. Her iki tipin de temini mümkündür.

FREON SLANGFITTINGEN
 FREON HOSE FITTINGS
 RACCORDS POUR TUYAUX AIRCONDITIONNE
 ARMATUREN FÜR KÄLTEMITTELSCHLAUCH
 FREON HORTUM RAKORLARI



Ref. BURGA CLIP®	aansluitmaat fitt.conn.size module du filetage Größe Verschraubung rakor ölçüsü	slangmaat hoze size module du tuyau Schlauchgröße hortum ölçüsü	draad thread filetage Gewinde diş ölçüsü	ventiel valve valve Ventil subap	D	R	FITTINGEN FITTINGS RACCORDS ARMATUREN RAKORLAR
----------------------------	---	---	--	--	---	---	--



54734-10-08S	-10	- 8	1-14	16	10	62
54734-10-10S	-10	-10	1-14	13	10	62
54734-10-12S	-10	-12	1-14	13	10	62

Tube "O" compressor wartel, 45°/R134 ventiel
 Tube "O" compressor fitting, 45°/R134 valve
 Raccord tube "O" compresseur, 45°/R134 valve
 Kompressoranschluss, 45°, "Tube O"/FV R134a



54706-06-06S	- 6	- 6	5/8-18		30	40
54706-08-06S	- 8	- 6	3/4-16		35	50
55706-10-06S	-10	- 6	7/8-14		40	60
54706-08-08S	- 8	- 8	3/4-16		35	50
54706-10-08S	-10	- 8	7/8-14		40	60
54706-08-10S	- 8	-10	3/4-16		35	50
54706-10-10S	-10	-10	7/8-14		40	57
54706-10-12S	-10	-12	7/8-14		40	57
54706-12-10S	-12	-10	1 1/16-14		45	65
54706-12-12S	-12	-12	1 1/16-14		45	65
54706-12-16S	-12	-16	1 1/16-14		45	65

"O" ring wartel, 90° - pijp aansluiting
 "O" ring female 90° swivel - tube connection
 "O" ring femelle tournant, 90° - tube connection
 Fitting, 90° mit ORL und Ü-Mutter

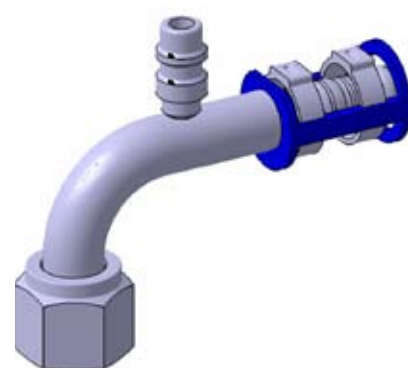

54719-06-06S	- 6	- 6	5/8-18	16	30	40
54719-08-08S	- 8	- 8	3/4-16	16	35	50
54719-10-08S	-10	- 8	7/8-14	16	40	60
54719-08-10S	- 8	-10	3/4-16	13	35	50
54719-10-10S	-10	-10	7/8-14	13	40	57
54719-10-12S	-10	-12	7/8-14	13	40	57
54719-12-12S	-12	-12	1 1/16-14	13	45	65
54719-12-14S	-12	-14	1 1/16-14	13	45	65
54719-12-16S	-12	-16	1 1/16-14	13	45	65

"O" ring wartel, 90°/R134 ventiel
 "O" ring female swivel, 90°/R134 valve
 "O" ring écrou tournant, 90°/R134 valve
 Fitting, 90° mit ORL und Ü-Mutter/FV R134a



FREON SLANGFITTINGEN
FREON HOSE FITTINGS
RACCORDS POUR TUYAUX AIRCONDITIONNE
ARMATUREN FÜR KÄLTEMITTELSCHLAUCH
FREON HORTUM RAKORLARI

FITTINGEN FITTINGS RACCORDS ARMATUREN RAKORLAR	Ref. BURGA CLIP®	aansluitmaat fitt.conn.size module du filetage Größe Verschraubung rakor ölçüsü	slangmaat hoze size module du tuyau Schlauchgröße hortum ölçüsü	draad thread filetage Gewinde diş ölçüsü	ventiel valve valve Ventil subap	D	R
--	----------------------------	---	---	--	--	---	---

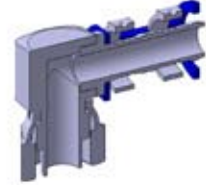
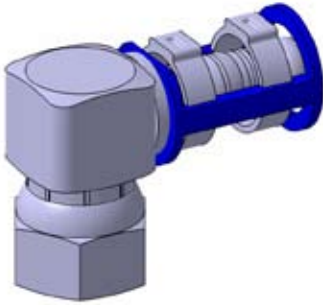

54740-06-06S	- 6	- 6	5/8-18		25	15
54740-08-08S	- 8	- 8	3/4-16		25	15
54740-10-10S	-10	-10	7/8-14		25	15
54740-12-12S	-12	-12	1 1/16-14		27	15
54740-12-14S	-12	-14	1 1/16-14		27	15
54740-12-16S	-12	-16	1 1/16-14		27	15

"O" ring wartel pijp, 90°, bloktype
 "O" ring female swivel, 90°, blocktype
 "O" ring femelle tournant, 90°, block
 Fitting, 90°-Blockausf./ORL/Ü-Mutter

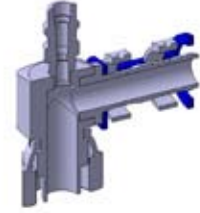

54742-06-06S	- 6	- 6	5/8-18	16	25	15
54742-08-08S	- 8	- 8	3/4-16	16	25	15
54742-10-10S	-10	-10	7/8-14	13	25	15
54742-12-12S	-12	-12	1 1/16-14	13	27	15
54742-12-14S	-12	-14	1 1/16-14	13	27	15
54742-12-16S	-12	-16	1 1/16-14	13	27	15

"O" ring wartel, 90°, bloktype/R134 ventiel
 "O" ring female swivel, 90°, block/R134 valve
 "O" ring femelle tournant, 90°, block/valve R134
 Fitting, 90°-Blockausf./ORL/Ü-Mutter/FV R134a

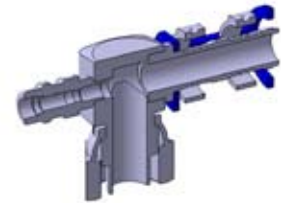
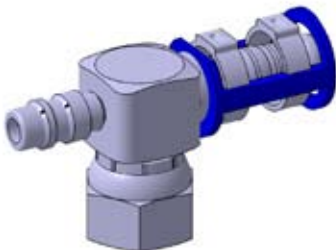

54412-06-06S	- 6	- 6	5/8-18	16	25	15
54412-08-08S	- 8	- 8	3/4-16	16	25	15
54412-10-10S	-10	-10	7/8-14	13	27	15
54412-12-12S	-12	-12	1 1/16-14	13	27	15

"O" ring wartel, 90°, bloktype/R134 ventiel recht
 "O" ring female swivel, 90°, block/R134 valve straight
 "O" ring femelle tournant, 90°, block/valve R134 droit
 Fitting, 90°-Blockausf./ORL/Ü-Mutter/FV R134a gerade

Fittingen uit één stuk of bestaande uit delen hebben een overeenkomstige maatvoering. Beide uitvoeringen kunnen worden geleverd.
 Raccords d'une seule pièce ou composé de pièces ont les mêmes dimensions. Les deux versions peuvent être fournies.
 Armaturen aus einem Stück oder aus mehreren Stücken haben dieselbe Abmessungen. Beide Ausführungen können geliefert werden.
 Tek parçadan oluşan rakorlar veya parça bileşenleri aynı ölçülere sahiptir. Her iki tipin de temini mümkündür.

FREON SLANGFITTINGEN
 FREON HOSE FITTINGS
 RACCORDS POUR TUYAUX AIRCONDITIONNE
 ARMATUREN FÜR KÄLTEMITTELSCHLAUCH
 FREON HORTUM RAKORLARI



Ref. BURGACLIP®	aansluitmaat fitt.conn.size module du filetage Größe Verschraubung rakor ölçüsü	slangmaat hoze size module du tuyau Schlauchgröße hortum ölçüsü	draad thread filetage Gewinde diş ölçüsü	ventiel valve valve Ventil subap	D	R	FITTINGEN FITTINGS RACCORDS ARMATUREN RAKORLAR
---------------------------	---	---	--	--	---	---	--

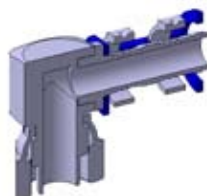

54421-10-08S	-10	- 8	7/8-14		17	15
54421-10-10S	-10	-10	7/8-14		17	15

SHORT DROP

"O" ring wartel pijp, 90°, bloktype
 "O" ring female swivel, 90°, blocktype
 "O" ring femelle tournant, 90°, block
 Fitting, 90°-Blockausf./ORL/Ü-Mutter

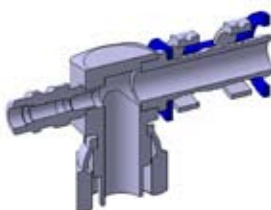

54422-10-08S	-10	- 8	7/8-14	16	17	15
54422-10-10S	-10	-10	7/8-14	13	17	15

SHORT DROP

"O" ring wartel, 90°, bloktype/R134 ventiel recht
 "O" ring female swivel, 90°, block/R134 valve straight
 "O" ring femelle tournant, 90°, block/valve R134 droit
 Fitting, 90°-Blockausf./ORL/Ü-Mutter/FV R134a gerade



FREON SLANGFITTINGEN
FREON HOSE FITTINGS
RACCORDS POUR TUYAUX AIRCONDITIONNE
ARMATUREN FÜR KÄLTEMITTELSCHLAUCH
FREON HORTUM RAKORLARI

FITTINGEN FITTINGS RACCORDS ARMATUREN RAKORLAR	Ref. BURGA CLIP®	aansluitmaat fitt.conn.size module du filetage Größe Verschraubung rakor ölçüsü	slangmaat hoze size module du tuyau Schlauchgröße hortum ölçüsü	draad thread filetage Gewinde diş ölçüsü	ventiel valve valve Ventil subap	D	R
--	----------------------------	---	---	--	--	---	---



Tube "O" compressor wartel, 90°/R134 ventiel
 Tube "O" compressor fitting, 90°/R134 valve
 Raccord tube "O" compresseur, 90°/valve R134
 Kompressoranschluss, 90°, Tube "O"/FV R134a

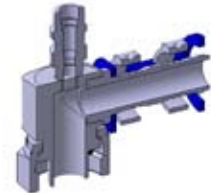

54735-10-08S	-10	- 8	1-14	16	18	15
54735-10-10S	-10	-10	1-14	13	18	15
54735-10-12S	-10	-12	1-14	13	18	15

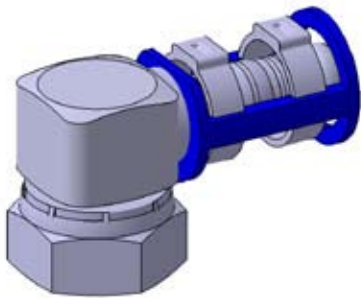

Tube "O" compressor wartel, 90° gebogen
 Tube "O" compressor fitting, 90° elbow
 Raccord tube "O" compresseur, coudé 90°
 Kompressoranschluss, 90°, "Tube O"

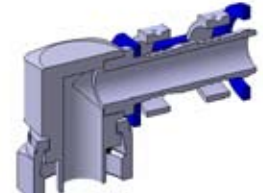

54709-10-08S	-10	- 8	1-14		18	15
54709-10-10S	-10	-10	1-14		18	15
54709-10-12S	-10	-12	1-14		18	15

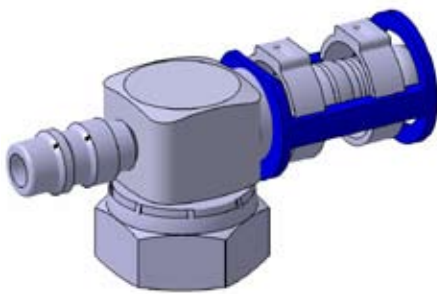

Tube "O" compressor wartel, 90°/R134 ventiel recht
 Tube "O" compressor fitting, 90°/R134 valve straight
 Raccord tube "O" compresseur, 90°/valve R134 droit
 Kompressoranschluss, 90°, "Tube O"/FV R134a gerade

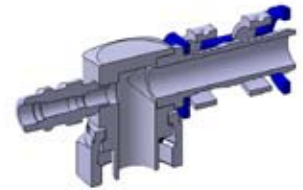

54435-10-08S	-10	- 8	1-14	16	18	15
54435-10-10S	-10	-10	1-14	13	18	15
54435-10-12S	-10	-12	1-14	13	18	15

Fittingen uit één stuk of bestaande uit delen hebben een overeenkomstige maatvoering. Beide uitvoeringen kunnen worden geleverd.
 One piece fittings or composed of parts have the same measurements. Both versions can be supplied.
 Raccords d'une seule pièce ou composé de pièces ont les mêmes dimensions. Les deux versions peuvent être fournies.
 Armaturen aus einem Stück oder aus mehreren Stücken haben dieselbe Abmessungen. Beide Ausführungen können geliefert werden.
 Tek parçadan oluşan rakorlar veya parça bileşenleri aynı ölçülere sahiptir. Her iki tipin de temini mümkündür.

FREON SLANGFITTINGEN
 FREON HOSE FITTINGS
 RACCORDS POUR TUYAUX AIRCONDITIONNE
 ARMATUREN FÜR KÄLTEMITTELSCHLAUCH
 FREON HORTUM RAKORLARI



Ref. BURGA CLIP®	aansluitmaat fitt.conn.size module du filetage Größe Verschraubung rakor ölçüsü	slangmaat hoze size module du tuyau Schlauchgröße hortum ölçüsü	draad thread filetage Gewinde diş ölçüsü	ventiel valve valve Ventil subap	D	R	FITTINGEN FITTINGS RACCORDS ARMATUREN RAKORLAR
----------------------------	---	---	--	--	---	---	--

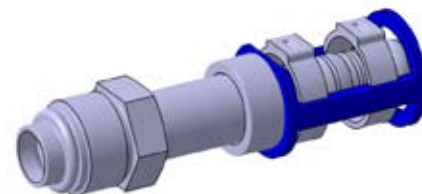
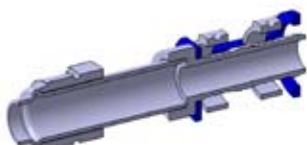

54213-06-06S	- 6	- 6	5/8-18			37
54213-06-08S	- 6	- 8	5/8-18			37
54213-08-08S	- 8	- 8	3/4-18			47
54213-10-10S	-10	-10	7/8-18			57
54213-10-12S	-10	-12	7/8-18			57
54213-12-12S	-12	-12	1 1/16-16			60
54213-12-14S	-12	-14	1 1/16-16			60
54213-12-16S	-12	-16	1 1/16-16			60

"O" ring wartel buitendraad
 "O" ring male swivel
 "O" ring écrou tournant mâle
 Fitting ORS, mit Ü-Schraube



54215-06-06S	- 6	- 6	5/8-18		22	50
54215-08-08S	- 8	- 8	3/4-18		25	55
54215-10-10S	-10	-10	7/8-18		27	67
54215-12-12S	-12	-12	1 1/16-16		35	80
54215-12-14S	-12	-14	1 1/16-16		35	80
54215-12-16S	-12	-16	1 1/16-16		35	80

"O" ring wartel buitendraad - 45° gebogen
 "O" ring male swivel - 45° elbow
 "O" ring écrou tournant mâle - coudé 45°
 Fitting 45° mit ORS / Ü-Schraube



54726-06-06S	- 6	- 6			30	40
54726-08-08S	- 8	- 8			35	50
54726-10-10S	-10	-10			40	57
54726-10-12S	-10	-12			40	57
54726-12-10S	-12	-10			45	65
54726-12-12S	-12	-12			45	65
54726-12-14S	-12	-14			45	65
54726-12-16S	-12	-16			45	65

"O" ring - pijp zonder moer, 90°
 "O" ring tube connection, without nut, 90°
 "O" ring tube connection, sans écrou, 90°
 Fitting, 90°, ORL ohne Ü-Mutter



FREON SLANGFITTINGEN
FREON HOSE FITTINGS
RACCORDS POUR TUYAUX AIRCONDITIONNE
ARMATUREN FÜR KÄLTEMITTELSCHLAUCH
FREON HORTUM RAKORLARI

FITTINGEN FITTINGS RACCORDS ARMATUREN RAKORLAR	Ref. BURGA CLIP®	aansluitmaat fitt.conn.size module du filetage Größe Verschraubung rakor ölçüsü	slangmaat hoze size module du tuyau Schlauchgröße hortum ölçüsü	draad thread filetage Gewinde diş ölçüsü	ventiel valve valve Ventil subap	D	R
--	----------------------------	---	---	--	--	---	---



54214-06-06S	- 6	- 6	5/8-18		40	32
54214-08-08S	- 8	- 8	3/4-18		45	40
54214-10-10S	-10	-10	7/8-18		52	50
54214-12-12S	-12	-12	1 1/16-16		60	60
54214-12-14S	-12	-14	1 1/16-16		60	60
54214-12-16S	-12	-16	1 1/16-16		60	60

"O" ring wartel buitendraad - 90° gebogen
 "O" ring male swivel - 90° elbow
 "O" ring écrou tournant mâle - coudé 90°
 Fitting 90° mit ORS / Ü-Schraube



54217-06-06S	- 6	- 6	5/8-18	16	40	32
54217-08-08S	- 8	- 8	3/4-18	16	45	40
54217-10-10S	-10	-10	7/8-18	13	52	50
54217-12-12S	-12	-12	1 1/16-16	13	60	60
54217-12-14S	-12	-14	1 1/16-16	13	60	60
54217-12-16S	-12	-16	1 1/16-16	13	60	60

"O" ring wartel buitendraad - 90° gebogen /
 R134 ventiel
 "O" ring male swivel - 90° elbow / R134 valve
 "O" ring écrou tournant mâle - coudé 90° /
 R134 valve
 Fitting 90° mit ORS / Ü-Schraube / FV R134a

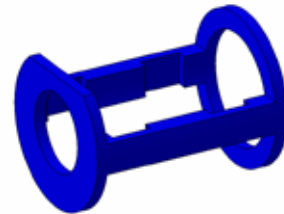
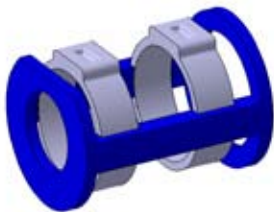

	8768-06		8769-06			
	8768-08		8769-08			
	8768-10		8769-10			
	8768-12		8769-12			
	8768-14		8769-14			
	8768-16		8769-16			

Plastic Clipholder met RVS Clips
 Plastic Clipholder with Clips
 Étriers de fixation plastique avec Clips
 Kunststoff Clipbügel mit Clips

Fittingen uit één stuk of bestaande uit delen hebben een overeenkomstige maatvoering. Beide uitvoeringen kunnen worden geleverd.
 One piece fittings or composed of parts have the same measurements. Both versions can be supplied.
 Raccords d'une seule pièce ou composé de pièces ont les mêmes dimensions. Les deux versions peuvent être fournies.
 Armaturen aus einem Stück oder aus mehreren Stücken haben dieselbe Abmessungen. Beide Ausführungen können geliefert werden.
 Tek parçadan oluşan rakorlar veya parça bileşenleri aynı ölçülere sahiptir. Her iki tipin de temini mümkündür.

FREON SLANGFITTINGEN
 FREON HOSE FITTINGS
 RACCORDS POUR TUYAUX AIRCONDITIONNE
 ARMATUREN FÜR KÄLTEMITTELSCHLAUCH
 FREON HORTUM RAKORLARI



Ref. BURGACLIP®	aansluitmaat fitt.conn.size module du filetage Größe Verschraubung rakor ölçüsü	slangmaat hoze size module du tuyau Schlauchgröße hortum ölçüsü	draad thread filetage Gewinde diş ölçüsü	ventiel valve valve Ventil subap	D	R	FITTINGEN FITTINGS RACCORDS ARMATUREN RAKORLAR
---------------------------	---	---	--	--	---	---	--

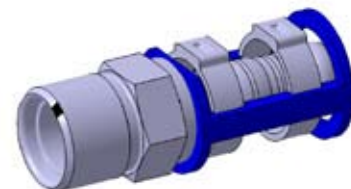
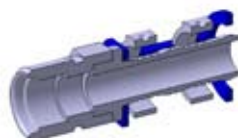

54206-06-06S	- 6	- 6	5/8-18			22
54206-08-08S	- 8	- 8	3/4-16			25
54206-10-10S	-10	-10	7/8-14			30
54206-12-12S	-12	-12	1 1/16-14			35
54206-12-14S	-12	-14	1 1/16-14			35
54206-12-16S	-12	-16	1 1/16-14			35

"O" ring buitendraad, recht
 Male insert "O" ring, straight
 Raccord mâle "O" ring
 Fitting, gerade mit Gewindestutzen



54207-06-06S	- 6	- 6	5/8-18		30	75
54207-08-08S	- 8	- 8	3/4-16		35	90
54207-10-10S	-10	-10	7/8-14		35	97
54207-12-12S	-12	-12	1 1/16-14		45	102
54207-12-14S	-12	-14	1 1/16-14		45	102
54207-12-16S	-12	-16	1 1/16-14		45	102

"O" ring buitendraad, 45° gebogen
 Male insert "O" ring, 45° elbow
 Raccord mâle "O" ring, coudé 45°
 Fitting, 45° mit Gewindestutzen



54208-06-06S	- 6	- 6	5/8-18		40	60
54208-08-08S	- 8	- 8	3/4-16		55	65
54208-10-10S	-10	-10	7/8-14		65	70
54208-12-12S	-12	-12	1 1/16-14		70	75
54208-12-14S	-12	-14	1 1/16-14		70	75
54208-12-16S	-12	-16	1 1/16-14		70	75

"O" ring buitendraad, 90° gebogen
 Male insert "O" ring, 90° elbow
 Raccord mâle "O" ring, coudé 90°
 Fitting, 90° mit Gewindestützen



FREON SLANGFITTINGEN
FREON HOSE FITTINGS
RACCORDS POUR TUYAUX AIRCONDITIONNE
ARMATUREN FÜR KÄLTEMITTELSCHLAUCH
FREON HORTUM RAKORLARI

FITTINGEN FITTINGS RACCORDS ARMATUREN RAKORLAR	Ref. BURGA CLIP®	aansluitmaat fitt.conn.size module du filetage Größe Verschraubung rakor ölçüsü	slangmaat hoze size module du tuyau Schlauchgröße hortum ölçüsü	draad thread filetage Gewinde diş ölçüsü	ventiel valve valve Ventil subap	D	R
--	----------------------------	---	---	--	--	---	---

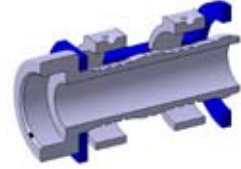
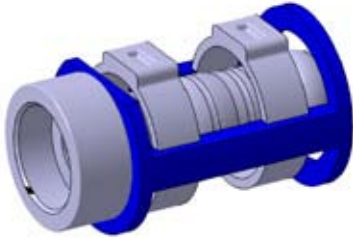

54743-06-06S	3/8	- 6					
54743-08-08S	1/2	- 8					
54743-10-10S	5/8	-10					
54743-12-10S	3/4	-10					
54743-12-12S	3/4	-12					
54743-12-14S	3/4	-14					
54743-16-16S	1	-16					

Lasnippel
Braze nipple
Nipple à souder
Löt-Nippel

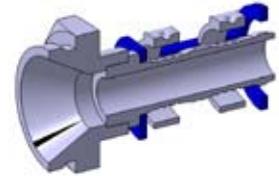
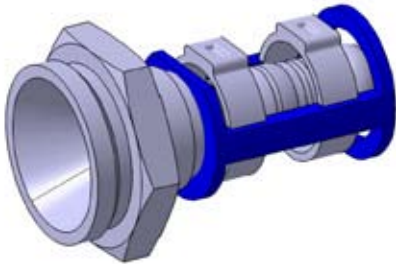

54747-08-06S	- 8	- 6	7/8-20			25
54747-12-10S	-12	-10	1 1/4-18			25

Snelkoppeling aansluiting
Quick disconnect connection
Raccord rapide connection
Schnelltrenn-Fitting

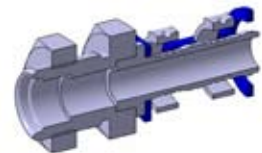
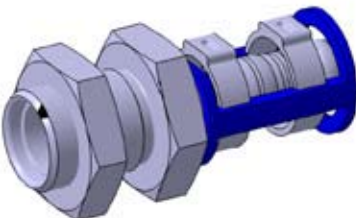

54758-06-06S	- 6	- 6	5/8-18			37
54758-08-08S	- 8	- 8	3/4-16			37
54758-10-10S	-10	-10	7/8-14			37
54758-12-12S	-12	-12	1 1/16-14			37
54758-12-14S	-12	-14	1 1/16-14			37
54758-12-16S	-12	-16	1 1/16-14			37

Schotdoorvoer "O" ring buitendraad, recht
Bulkhead male insert "O" ring straight
Raccord de cloison mâle "O" ring
Fitting, gerade mit Schottverschraubung

Fittingen uit één stuk of bestaande uit delen hebben een overeenkomstige maatvoering. Beide uitvoeringen kunnen worden geleverd.
 Raccords d'une seule pièce ou composé de pièces ont les mêmes dimensions. Les deux versions peuvent être fournies.
 Armaturen aus einem Stück oder aus mehreren Stücken haben dieselbe Abmessungen. Beide Ausführungen können geliefert werden.
 Tek parçadan oluşan rakorlar veya parça bileşenleri aynı ölçülere sahiptir. Her iki tipin de temini mümkündür.

FREON SLANGFITTINGEN
 FREON HOSE FITTINGS
 RACCORDS POUR TUYAUX AIRCONDITIONNE
 ARMATUREN FÜR KÄLTEMITTELSCHLAUCH
 FREON HORTUM RAKORLARI



Ref. BURGA CLIP®	aansluitmaat fitt.conn.size module du filetage Größe Verschraubung rakor ölçüsü	slangmaat hoze size module du tuyau Schlauchgröße hortum ölçüsü	draad thread filetage Gewinde diş ölçüsü	ventiel valve valve Ventil subap	D	R	FITTINGEN FITTINGS RACCORDS ARMATUREN RAKORLAR
----------------------------	---	---	--	--	---	---	--



54759-06-06S	- 6	- 6	5/8-18		55	52
54759-08-08S	- 8	- 8	3/4-16		65	52
54759-10-10S	-10	-10	7/8-14		75	52
54759-12-12S	-12	-12	1 1/16-14		100	65
54759-12-14S	-12	-14	1 1/16-14		100	65
54759-12-16S	-12	-16	1 1/16-14		100	65

Schotdoorvoer "O" ring buitendraad, 90° gebogen
 Bulkhead male insert "O" ring, 90° elbow
 Raccord de cloison mâle "O" ring, coudé 90°
 Fitting, 90° mit Schottverschraubung



54760-06-06S	- 6	- 6	5/8-18		40	82
54760-08-08S	- 8	- 8	3/4-16		45	95
54760-10-10S	-10	-10	7/8-14		47	97
54760-12-12S	-12	-12	1 1/16-14		50	100
54760-12-14S	-12	-14	1 1/16-14		50	100
54760-12-16S	-12	-16	1 1/16-14		50	100

Schotdoorvoer "O" ring buitendraad, 45° gebogen
 Bulkhead male insert "O" ring, 45° elbow
 Raccord de cloison mâle "O" ring, coudé 45°
 Fitting, 45° mit Schottverschraubung

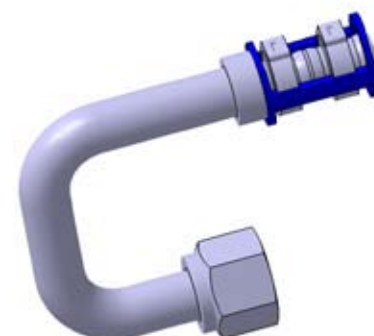

54771-06-06S	- 6	- 6	5/8-18		50	62/42
54771-08-08S	- 8	- 8	3/4-16		60	62/45
54771-10-10S	-10	-10	7/8-14		70	80/60
54771-12-12S	-12	-12	1 1/16-14		80	95/60
54771-12-14S	-12	-14	1 1/16-14		80	95/60
54771-12-16S	-12	-16	1 1/16-14		80	95/60

"O" ring wartel, 180° - pijp aansluiting
 "O" ring female 180° swivel - tube connection
 "O" ring femelle tournant, 180° - tube connection
 Fitting, 180° mit Ü-Mutter



FREON SLANGFITTINGEN
FREON HOSE FITTINGS
RACCORDS POUR TUYAUX AIRCONDITIONNE
ARMATUREN FÜR KÄLTEMITTELSCHLAUCH
FREON HORTUM RAKORLARI

FITTINGEN FITTINGS RACCORDS ARMATUREN RAKORLAR	Ref. BURGA CLIP®	aansluitmaat fitt.conn.size module du filetage Größe Verschraubung rakor ölçüsü	slangmaat hoze size module du tuyau Schlauchgröße hortum ölçüsü	draad thread filetage Gewinde diş ölçüsü	ventiel valve valve Ventil subap	D	R
--	----------------------------	---	---	--	--	---	---

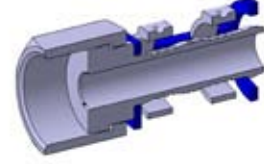
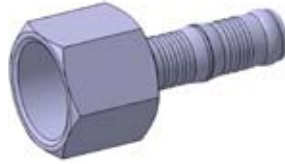
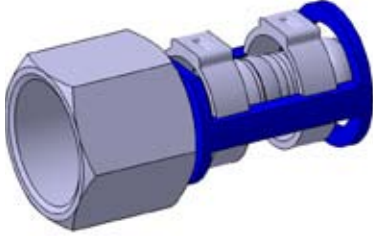

54501-04-06S	- 4	- 6	9/16-18			10
54501-06-06S	- 6	- 6	11/16-16			10
54501-08-08S	- 8	- 8	13/16-16			12
54501-10-10S	- 10	- 10	1-14			15
54501-12-12S	- 12	- 12	1 3/16-12			15
54501-16-16S	- 16	- 16	1 7/16-12			15

ORFS wartel
 ORFS female swivel
 ORFS femelle tournant
 Fiting, gerade mit ORFS/ Ü-Mutter

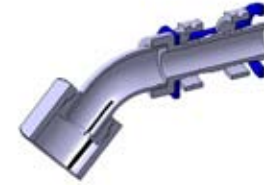
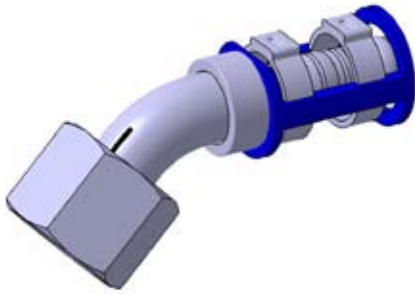

54502-04-06S	- 4	- 6	9/16-18		15	45
54502-06-06S	- 6	- 6	11/16-16		15	45
54502-08-08S	- 8	- 8	13/16-16		15	52
54502-10-10S	- 10	- 10	1-14		17	55
54502-10-12S	- 10	- 12	1-14		17	55
54502-12-12S	- 12	- 12	1 3/16-12		25	75
54502-16-16S	- 16	- 16	1 7/16-12		30	80

ORFS wartel - 45° elleboog
 ORFS female swivel - 45° elbow
 ORFS femelle tournant - coudé 45°
 Fitting, 45° mit ORFS/ Ü-Mutter



54503-04-06S	- 4	- 6	9/16-18		30	40
54503-06-06S	- 6	- 6	11/16-16		30	40
54503-06-08S	- 6	- 8	11/16-16		30	40
54503-08-08S	- 8	- 8	13/16-16		35	50
54503-08-10S	- 8	- 10	13/16-16		35	50
54503-10-10S	- 10	- 10	1/14		40	50
54503-12-12S	- 12	- 12	1 3/16-12		50	60
54503-16-16S	- 16	- 16	1 7/16-12		60	70

ORFS wartel - 90° elleboog
 ORFS female swivel - 90° elbow
 ORFS femelle tournant - coudé 90°
 Fitting, 90° mit ORFS/ Ü-Mutter

Fittingen uit één stuk of bestaande uit delen hebben een overeenkomstige maatvoering. Beide uitvoeringen kunnen worden geleverd.
 One piece fittings or composed of parts have the same measurements. Both versions can be supplied.
 Raccords d'une seule pièce ou composé de pièces ont les mêmes dimensions. Les deux versions peuvent être fournies.
 Armaturen aus einem Stück oder aus mehreren Stücken haben dieselbe Abmessungen. Beide Ausführungen können geliefert werden.
 Tek parçadan oluşan rakorlar veya parça bileşenleri aynı ölçülere sahiptir. Her iki tipin de temini mümkündür.

FREON SLANGFITTINGEN
 FREON HOSE FITTINGS
 RACCORDS POUR TUYAUX AIRCONDITIONNE
 ARMATUREN FÜR KÄLTEMITTELSCHLAUCH
 FREON HORTUM RAKORLARI



Ref. BURGACLIP®	aansluitmaat fitt.conn.size module du filetage Größe Verschraubung rakor ölçüsü	slangmaat hoze size module du tuyau Schlauchgröße hortum ölçüsü	draad thread filetage Gewinde diş ölçüsü	ventiel valve valve Ventil subap	D	R	FITTINGEN FITTINGS RACCORDS ARMATUREN RAKORLAR
---------------------------	---	---	--	--	---	---	--

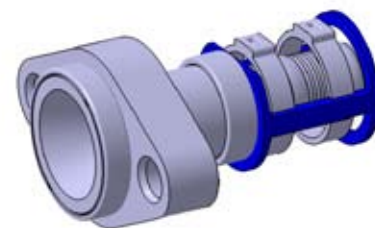
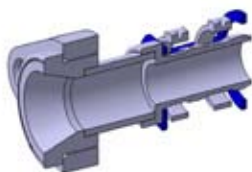

54754-16-14S	-16	-14				50	
54754-16-16S	-16	-16				50	

“Bock” flensaansluiting
 “Bock” flange connection
 A bride “Bock”
 “Bock” Anschluss

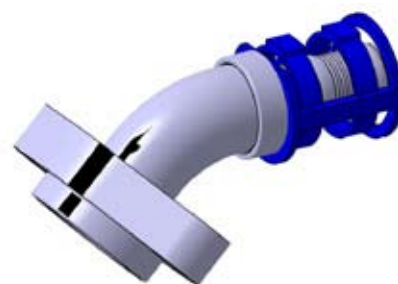
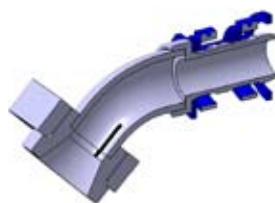

54755-16-14S	-16	-14			30	57	
54755-16-16S	-16	-16			30	57	

“Bock” flensaansluiting 45° elleboog
 “Bock” flange connection 45° elbow
 A bride “Bock” coudé 45°
 “Bock” Anschluss 45°



54757-16-14S	-16	-14			63	49	
54757-16-16S	-16	-16			63	49	

“Bock” flensaansluiting 90° elleboog
 “Bock” flange connection 90° elbow
 A bride “Bock” coudé 90°
 “Bock” Anschluss 90°



FREON SLANGFITTINGEN
FREON HOSE FITTINGS
RACCORDS POUR TUYAUX AIRCONDITIONNE
ARMATUREN FÜR KÄLTEMITTELSCHLAUCH
FREON HORTUM RAKORLARI

FITTINGEN FITTINGS RACCORDS ARMATUREN RAKORLAR	Ref. BURGA CLIP®	aansluitmaat fitt.conn.size module du filetage Größe Verschraubung rakor ölçüsü	slangmaat hoze size module du tuyau Schlauchgröße hortum ölçüsü	draad thread filetage Gewinde diş ölçüsü	ventiel valve valve Ventil subap	D	R
--	----------------------------	---	---	--	--	---	---

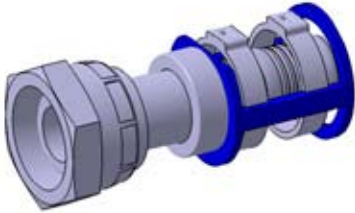

54901-22-14S	-22	-14	M30x2			44
54901-22-16S	-22	-16	M30x2			44

DIN 3865 - 24°
 Metrische wartel, lichte serie
 Metric swivel, light series
 Écrou tournant métrique, série légère
 Fitting metrische Mutter, leicht serien



54904-22-14S	-22	-14	M30x2		46	30
54904-22-16S	-22	-16	M30x2		46	30

DIN 3865 - 24°
 Metrische wartel, lichte serie - 90° elleboog
 Metric swivel, light series - 90° elbow
 Écrou tournant métrique, série légère - coudé 90°
 Fitting metrische Mutter, leicht serien 90°



54910-22-14S	-22	-14	M30x2		40	40
54910-22-16S	-22	-16	M30x2		40	40

DIN 3865 - 24°
 Metrische wartel, lichte serie - 45° elleboog
 Metric swivel, light series - 45° elbow
 Écrou tournant métrique, série légère - coudé 45°
 Fitting metrische Mutter, leicht serien 45°

Fittingen uit één stuk of bestaande uit delen hebben een overeenkomstige maatvoering. Beide uitvoeringen kunnen worden geleverd.
 One piece fittings or composed of parts have the same measurements. Both versions can be supplied.
 Raccords d'une seule pièce ou composé de pièces ont les mêmes dimensions. Les deux versions peuvent être fournies.
 Armaturen aus einem Stück oder aus mehreren Stücken haben dieselbe Abmessungen. Beide Ausführungen können geliefert werden.
 Tek parçadan oluşan rakorlar veya parça bileşenleri aynı ölçülere sahiptir. Her iki tipin de temini mümkündür.

FREON SLANGFITTINGEN
 FREON HOSE FITTINGS
 RACCORDS POUR TUYAUX AIRCONDITIONNE
 ARMATUREN FÜR KÄLTEMITTELSCHLAUCH
 FREON HORTUM RAKORLARI



Ref. BURGACLIP®	aansluitmaat fitt.conn.size module du filetage Größe Verschraubung rakor ölçüsü	slangmaat hoze size module du tuyau Schlauchgröße hortum ölçüsü	draad thread filetage Gewinde diş ölçüsü	ventiel valve valve Ventil subap	D	R	FITTINGEN FITTINGS RACCORDS ARMATUREN RAKORLAR
---------------------------	---	---	--	--	---	---	--

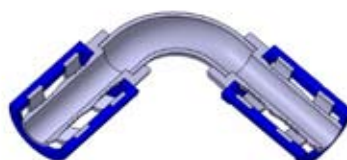

(54)8749-06-06		- 6			35	35	
(54)8749-08-08		- 8			40	40	
(54)8749-10-10		-10			45	45	
(54)8749-12-12		-12			52	52	

Verbindingsstuk 90°
 In line splicer 90°
 Splicer 90°
 Verbindungsstück 90°

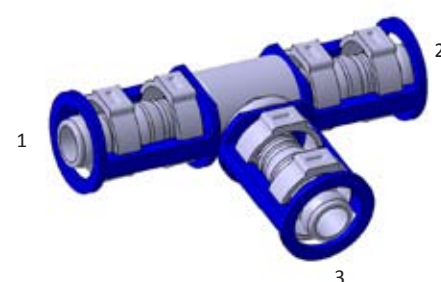
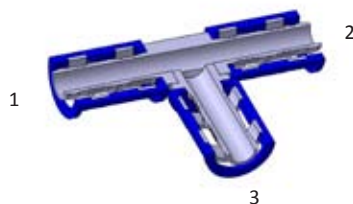

(54)8750-06-06-06		- 6			10	25	
(54)8750-08-06-06		- 8 / - 6			10	57	
(54)8750-08-08-08		- 8			12	25	
(54)8750-10-08-08		- 10 / - 8			12	57	
(54)8750-10-10-08		- 10 / - 8			15	25	
(54)8750-12-10-08		- 12 / - 10 / - 8			12	57	
(54)8750-10-10-10		- 10			15	25	
(54)8750-12-10-10		- 12 / - 10			15	57	
(54)8750-12-12-12		- 12			15	25	

T-verbindingsstuk
 T-splicer
 T-splicer
 T-Stück



(54)8751-06-06		- 6		16		25	
(54)8751-08-08		- 8		16		25	
(54)8751-10-10		-10		13		25	
(54)8751-12-12		-12		13		25	

Verbindingsstuk met R134 valve
 In line splicer with acces valve R134
 Splicer avec valve pour R134
 Verbindungsstück mit FV R134a



FREON SLANGFITTINGEN
FREON HOSE FITTINGS
RACCORDS POUR TUYAUX AIRCONDITIONNE
ARMATUREN FÜR KÄLTEMITTELSCHLAUCH
FREON HORTUM RAKORLARI

FITTINGEN FITTINGS RACCORDS ARMATUREN RAKORLAR	Ref. BURGA CLIP®	aansluitmaat fitt.conn.size module du filetage Größe Verschraubung rakor ölçüsü	slangmaat hoze size module du tuyau Schlauchgröße hortum ölçüsü	draad thread filetage Gewinde diş ölçüsü	ventiel valve valve Ventil subap	D	R
--	----------------------------	---	---	--	--	---	---



(54)8752-06-06-06			- 6			55	60
(54)8752-08-08-08			- 8			62	70
(54)8752-10-10-10			- 10			67	75
(54)8752-12-12-12			- 12			75	90

Y-verbindingstuk
Y-splicer
Y-splicer
Y-Stück

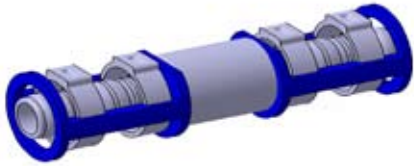

(54)8753-06-06			- 6				25
(54)8753-08-08			- 8				25
(54)8753-10-10			- 10				25
(54)8753-12-12			- 12				25

Verbindingsstuk
In line splicer
Splicer
Verbindungsstück

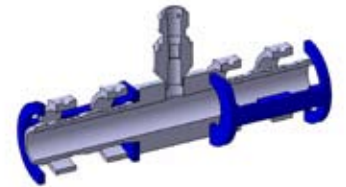

(54)8754-06-06			- 6				25
(54)8754-08-08			- 8				25
(54)8754-10-10			- 10				25
(54)8754-12-12			- 12				25

Verbindingsstuk met R12 valve
In line splicer with R12 valve
Splicer avec valve pour R12
Verbindungsstück mit FV R12

Fittingen uit één stuk of bestaande uit delen hebben een overeenkomstige maatvoering. Beide uitvoeringen kunnen worden geleverd.
 Raccords d'une seule pièce ou composé de pièces ont les mêmes dimensions. Les deux versions peuvent être fournies.
 Armaturen aus einem Stück oder aus mehreren Stücken haben dieselbe Abmessungen. Beide Ausführungen können geliefert werden.
 Tek parçadan oluşan rakorlar veya parça bileşenleri aynı ölçülere sahiptir. Her iki tipin de temini mümkündür.



1. De slang snijden.

Snij de slang op de juiste lengte met behulp van de Burgaflex snijtang (nr. 8767). Snij de slang haaks af.

Cut the hose.

Cut the hose to proper length with the Burgaflex hose cutter (nr. 8767). à couper. The cut must be made normal to the hose length.

Coupe du tuyau.

Couper le tuyau à la longueur désirée à l'aide de pince Burgaflex (nr. 8767). La coupe doit être perpendiculaire par rapport à l'axe du tuyau.

Schlauch abschneiden.

Den Schlauch mit dem Burgaflex Schneidewerkzeug (Nr. 8767) auf die richtige Länge zuschneiden. Der Schnitt muß im rechten Winkel zur Schlauchachse erfolgen.

Hortumu kesin.

Hortumu Burgaflex hortum makası (no. 8767) kullanarak istenen boyda hortumu kesin.



2. De twee clips in de clipholder plaatsen.

Plaats twee clips van het juiste formaat, in dezelfde richting, in de clipholder.

Place the two clips in the clip holder.

Install two proper-sized clips into the clipholder. For ease of assembly both clips should have the same orientation.

Placer les deux clips dans l'étriers de fixation.

Monter deux clips de taille appropriée dans l'étriers de fixation. Il est préférable que les deux clips soient orientés de même manière.

Vormontage der Clips in den Clip-halter.

Zwei Clips der entsprechenden Größe in den Clip-Halter stecken. Zur Vereinfachung der Montage sollten beide Clips gleich ausgerichtet sein.

İki adet kelepçeyi tutucu parçanın içine yerleştirin.

Uygun ölçülerde iki adet kelepçeyi plastik tutucu parçanın içine yerleştirin. Sıkma kolaylığı sağlamak için kelepçelerin sıkma çenelerinin aynı yönde olmaları gerekmektedir.



3. Clips en clipholder op de slang schuiven.

Plaats de clipholder met de twee clips op de slang. Zo, dat de zijde met de opening tegen het slangeinde aanligt.

Slip on the clipholder with the clips.

Place the clipholder with the two clips on the hose. In such a manner that the side with the smallest hole touches the end of the hose.

Montage d'étriers de fixation avec les clips.

Monter l'étriers de fixation avec les deux clips au Burgaclip fitting. De manière à ce que l'étrier soit du côté du tuyau.

Den Clip-Halter mit den Clips auf dem Schlauch montieren.

Der Clip-Halter mit den zwei Clips auf den Burgaflex-Kältemittelschlauch der entsprechenden Größe aufschieben, so daß die Seite mit der kleineren Öffnung am Schlauchende anliegt.

Tutucu parçayı kelepçeleriyle birlikte hortum üzerine yerleştirin.

Tutucu parçayı hortum çapına uygun delik yönünden düzgünce geçirerek yerleştirin. Tutucu parçanın alın yüzeyi ile hortumun alın yüzeyi tam temas sağlamalıdır.



MONTAGEHANDLEIDING
ASSEMBLY INSTRUCTION
INSTRUCTIONS DE MONTAGE
MONTAGEANLEITUNG

4. Burgaclip fitting smeren.

De fitting rijkelijk met PAG-olie insmeren. Dit is nodig om de fitting gemakkelijk in slang te schuiven.

Oil the Burgaclip fitting.

Lubricate the fitting with a generous amount of the A/C system's lubricator oil. This is to lower the force of the insertion.

Graissage du Burgaclip raccord.

Huiler abondamment le raccord avec de l'huile compresseur. Ceci est indispensable afin de réduire la force nécessaire pour introduire le raccord.

Die Armatur ölen.

Nippelende des Fittings leicht mit Kältemaschinenöl einölen um die zum aufsteckendes schlauches notwendige Kraft zu verringern.

Burgaclip rakoru uygun soğutma yağı ile yağlayın.

Rakurun hortuma rahatça girebilmesi için soğutma sisteminde kullanılacak kendi yağı ile rakor yağlanmalıdır.



5. De Burgaclip fitting in de slang brengen.

Breng de fitting in de slang. Om er zeker van te zijn dat de fitting volledig in de slang zit, mag er geen ruimte tussen de schouder en het einde van de slang zitten.

Insert the Burgaclip fitting into the hose.

Insert the fitting into the hose. Ensure that the fitting is fully inserted by checking the gap between the end of the hose and the shoulder of the fitting.

Introduction du Burgaclip raccord dans le tuyau.

Introduire le raccord dans le tuyau. jusqu'au contact de l'étrier.

Montage der Burgaclip Armatur

Fitting durch den Clip-Halter in den Schlauch stecken. Darauf achten, dass der Nippelbund am Anschlag des Clip-Halters anliegt.

Burgaclip rakoru hortuma sokun.

Rakurun hortuma doğru ve tam yerleştirildiğinden ve hortum ile rakurun alın altına tam temas sağladığından emin olun.



6. De RVS Clips sluiten.

Sluit beide Clips m.b.v. de Burgaflex Cliptang (nr. 8766). De tang opent zich als de juiste waarde is bereikt. Begin met de Clip het dichtst bij het slangeinde.

Close the clips.

Close both Clips with the Burgaflex Clip pliers (nr. 8766). The pliers open themselves when the right force has been reached. Start with the clip closest to the end of the hose.

Fermeture des clips.

Ouvrir la pince (nr. 8766) pour introduire les becs de clips. Puis refermer totalement la pince pour libérer les becs du clips.

Die Clips schließen.

Mit Hilfe der Burgaflex-Montagezange (Nr. 8766) beide Clips schliessen, wobei sich die Zange erst nach dem Erreichen des korrekten Pressmaßes wieder öffnen lässt. Beginnen Sie dabei mit dem Clip, der Richtung Schlauch positioniert ist.

Kelepçeleri sıkın.

Her iki kelepçeyi Burgaflex kelepçe sıkıcı el aleti (no.8766) kullanarak sıkın. Sıkıcı el aleti kelepçe tam olarak sıkıldığı anda kendi kendine açılacaktır. İlk olarak hortum ucundaki kelepçeyi sıkımla başlayın.



7. Klaar!

U heeft nu een slang/fitting-verbinding gerealiseerd die een duurzame afsluiting mogelijk maakt.

Done!

Now you have realized a durable hose/fitting connection.

Fin!

Vous avez réalisé un raccordement durable.

Fertig!

Sie haben jetzt eine definiert verpresste Verbindung hergestellt, die dauerhafte Dichtigkeit gewährleistet.

Hazır!

İşte şimdi uzun ömürlü bir hortum/rakor bağlantısını kolayca gerçekleştirdiniz.

Fittings uit één stuk of bestaande uit delen hebben een overeenkomstige maatvoering. Beide uitvoeringen kunnen worden geleverd. One piece fittings or composed of parts have the same measurements. Both versions can be supplied. Raccords d'une seule pièce ou composé de pièces ont les mêmes dimensions. Les deux versions peuvent être fournies. Armaturen aus einem Stück oder aus mehreren Stücken haben dieselbe Abmessungen. Beide Ausführungen können geliefert werden. Tek parçadan oluşan rakorlar veya parça bileşenleri aynı ölçülere sahiptir. Her iki tipin de temini mümkündür.

"O" RING T.B.V. R134A
"O" RING FOR R134A
"O" RING POUR R134A
"O" RINGE FÜR R134A
R134A İÇİN "O" RING



bestel nr. part no. référence Bestell Nr. parça no	I.D. (mm)	width (mm)	proposed torque (Nm)
--	--------------	---------------	-------------------------

7028-06	7.65	1.78	13,6-20,3
7028-08	10.82	1.78	32,5-42,0
7028-10	14.00	1.78	35,3-42,0
7028-12	17.17	1.78	40,7-47,5

54XXX-X-XS

54XXX = bestelnr., part no., référence,
Bestell Nr., parça no

X = aansluitmaat, fitt.conn.size,
module du filetage, Größe
Verschraubung, rakor ölçüsü

X = slangmaat, hoze size,
module du tuyau, Schlauchgröße,
hortum ölçüsü

S = staal, steel, çelik

Tolerantie maatvoering +/- 3 mm

Tolérance dimensions +/- 3 mm

Tolerance measurements +/- 3 mm

Toleranz Maßführung +/- 3 mm

Tolerans ölçüleri +/- 3 mm

CLIPTANG
CLIP PLIERS
PINCE CLIP
MONTAGEZANGE
KELEPÇE SIKICI

bestel nr.	8766
part no.	
référence	
Bestell Nr.	
parça no	



SNIJTANG
HOSE CUTTER
PINCE À COUPER
SCHNEIDWERKZEUG
HORTUM MAKASI

bestel nr.	8767
part no.	
référence	
Bestell Nr.	
parça no	



©Copyright 2010 Burgaflex bv
Niets uit deze uitgave mag worden overgenomen of
gereproduceerd zonder uitdrukkelijke schriftelijke toestemming van Burgaflex bv.

©Copyright 2010 Burgaflex bv
No contents of this catalogue may be reproduced without our prior written approval.

©Copyright 2010 Burgaflex bv
Toute réproduction même partielle, est formellement interdite.

©Copyright 2010 Burgaflex bv
Nichts auß diesem Katalog darf reproduziert würden ohne unseren schriftliche
Eintracht.

© Her hakkı saklıdır 2010 Burgaflex bv
Bu katalogdaki içerikler önceden yazılı izin alınmadan hiçbir şekilde kullanılamaz ve
çoğaltılamaz.

Maatvoering, afbeeldingen en teksten in deze folder zijn niet bindend.

Dimensions, pictures and text in this leaflet are not binding.

Ce document n'est pas contractuel et peut être modifié à tout moment.

Maßzahlen, Bilder und Text im dieser Katalog sind nicht bindend.

Üretici firma ölçüler, resimler ve tanımlamalar üzerinde değişiklik yapma hakkını saklı tutar.

Burgaflex BV Holland

Mon Plaisir 112
4879 AT Etten-Leur
P.O. Box 238
4870 AE Etten-Leur
Holland
Tel. +31(0)76 503 5000
Fax +31(0)76 501 3558
E-mail: info@burgaflex.nl

Burgaflex UK Ltd.

Unit 1.03 Phoenix Park Industrial Estate
Phoenix Close
Heywood, Lancs. OL10 2JG
United Kingdom
Tel. +44(0)1706 620 220
Fax +44(0)1706 620 611
E-mail: info@burgaflex.co.uk

Burgaflex Deutschland GmbH

Erlenstrasse 36
73663 Berglen-Steinach
Germany
Tel. +49(0)7195 13995-0
Fax +49(0)7195 13995-55
E-mail: info@burgaflex.de

Burgaflex North America Inc.

10160 Gainey Dr.
P.O. Box 435
Holly, Michigan 48442
United States of America
Tel. +1(0)810 714 32 85
Fax +1(0)810 714 34 92
E-mail: info@burgaflexna.com

www.burgaflex.com

